

SANCOM

SA-PAN034039-P46**3.4-3.9 GHz High Power GaN-HEMT**

Features

Frequency Range: 3.4-3.9 GHz

$P_{\text{sat}} \geq 46 \text{ dBm}$

Power Gain: $\geq 11 \text{ dB}$

Efficiency: $\geq 50\%$

$Z_{\text{in}}/Z_{\text{out}} = 50 \Omega$



Description

Sancom Electric's GaN-HEMT SA-PAN034039-P46 offers high power, high efficiency, ease of matching and greater consistency for high power applications with 28V operation. The SA-PAN034039-P46 typically provides 46 dBm of saturated output power and 11dB of large-signal gain and can be widely used in various RF/microwave systems.

ABSOLUTE MAXIMUM RATINGS

Parameter	Symbol	Condition	Rating	Unit
Drain-Source Voltage	V_{DS}	TC=25°C	40	V
Gate-Source Voltage	V_{GS}	TC=25°C	-5	V
Storage Temperature	T_{stg}	TC=25°C	-65 to 150	°C
Channel Temperature	T_{ch}	TC=25°C	150	°C

ELECTRICAL SPECIFICATIONS

Parameter	Symbol	Condition	Min	Typ	Max	Unit
Drain-Source Current	I_{DS}	V_{DS} : 28 V CW (Continuous Wave) P_{in} : 35 dBm Freq: 3.4 ~ 3.9 GHz	-	2.8	-	A
Saturated Power	P_{sat}		46	-	-	dBm
Power Gain	G_p		11	-	-	dB
Efficiency	η		50	-	-	%
Flatness	ΔG		-0.8	-	0.8	dB

Performance Plots

Saturated Power VS Frequency

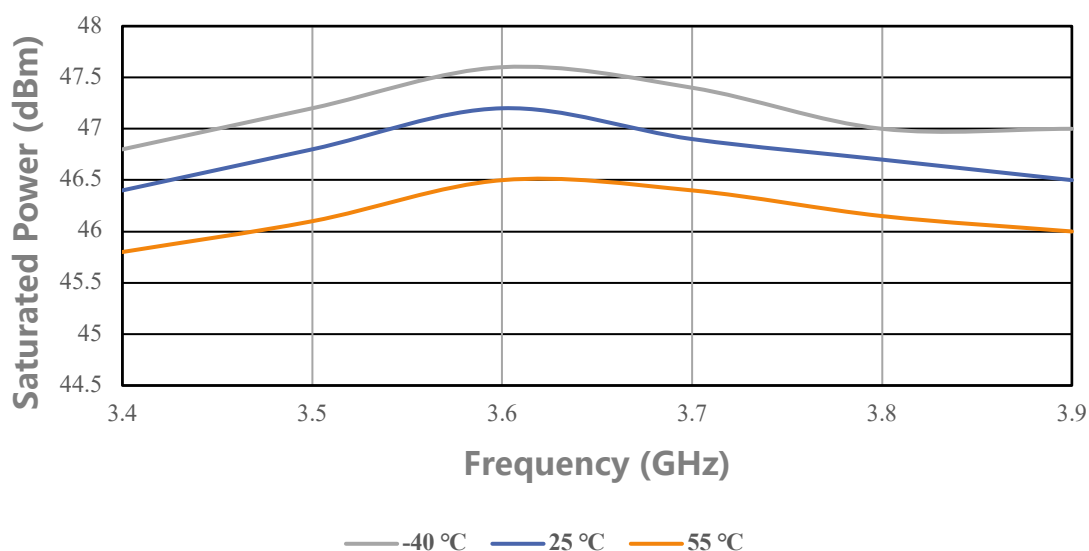

Efficiency VS Frequency

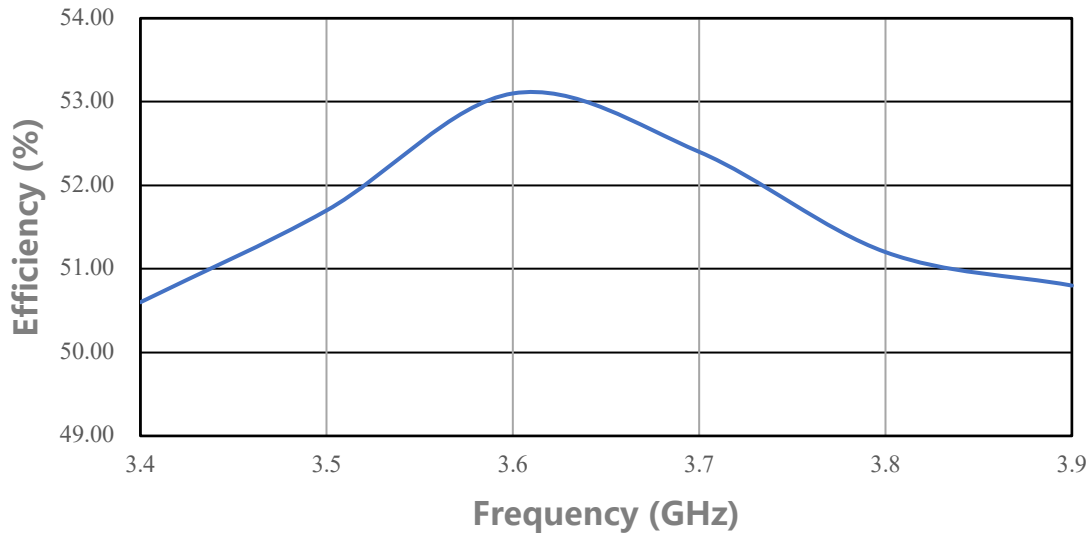

Power Gain VS Frequency

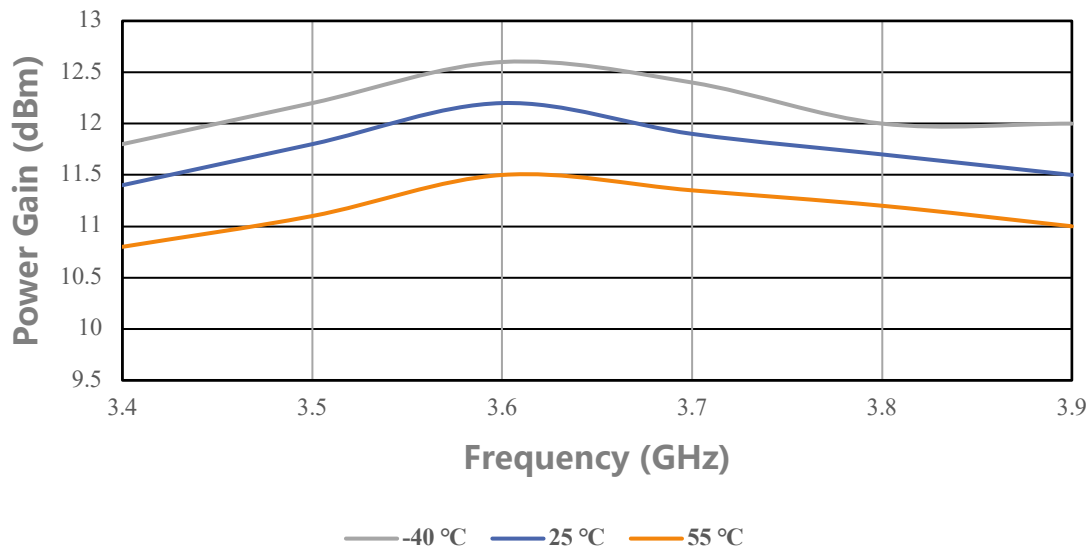

Simplified Block Diagram

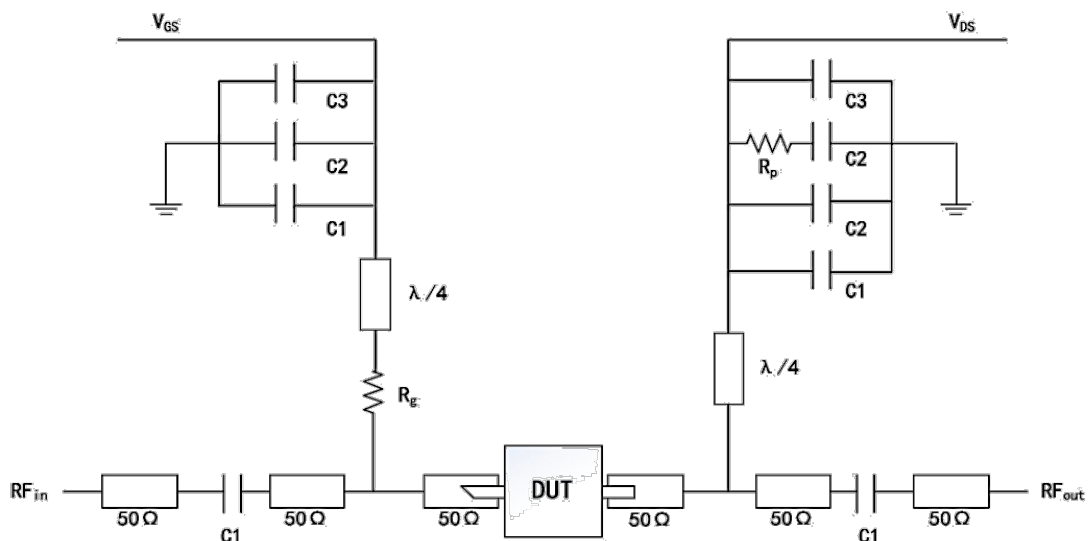

DUT information

C1: 8 pF	Rp: 51 Ω
C2: 1000 pF	Rg: 15 Ω
C3: 100 μ F	

ESD Protection

ESD	Class III	2000 V
-----	-----------	--------

Outline Drawing



Unit: mm

Attention

- Please keep away from moisture during transportation and storage
- Pay attention to ESD prevention during chip use and assembly. Wear a grounding ESD bracelet.
- When adding electricity, add gate electricity first and then add leakage electricity